

FWB2073-J

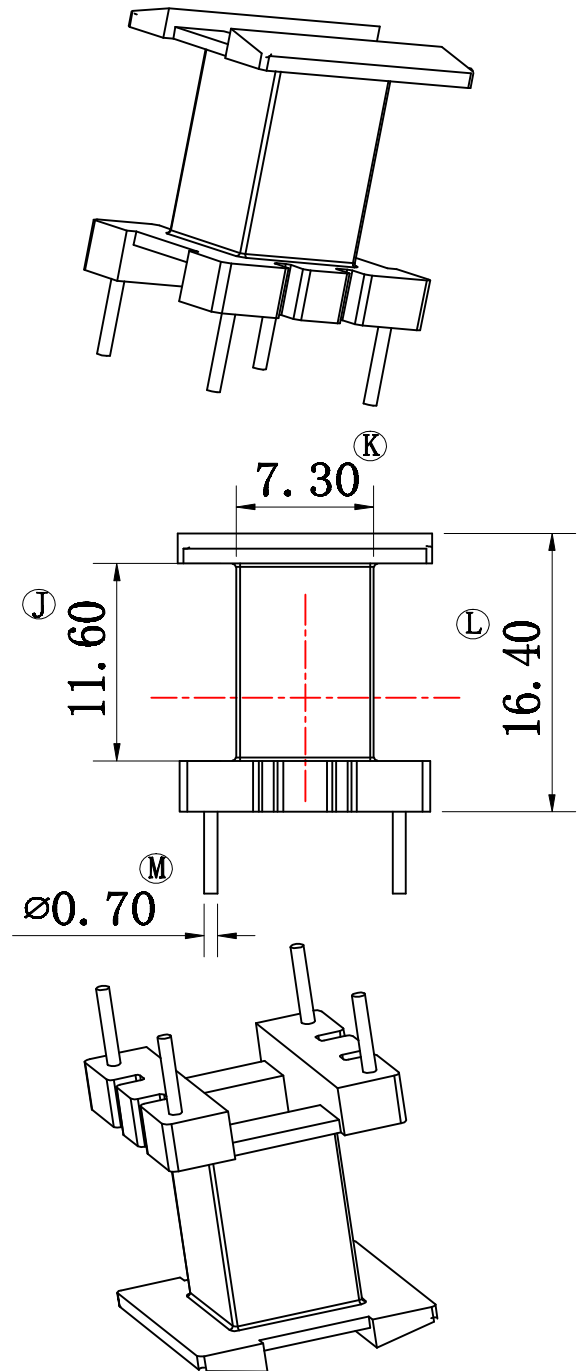
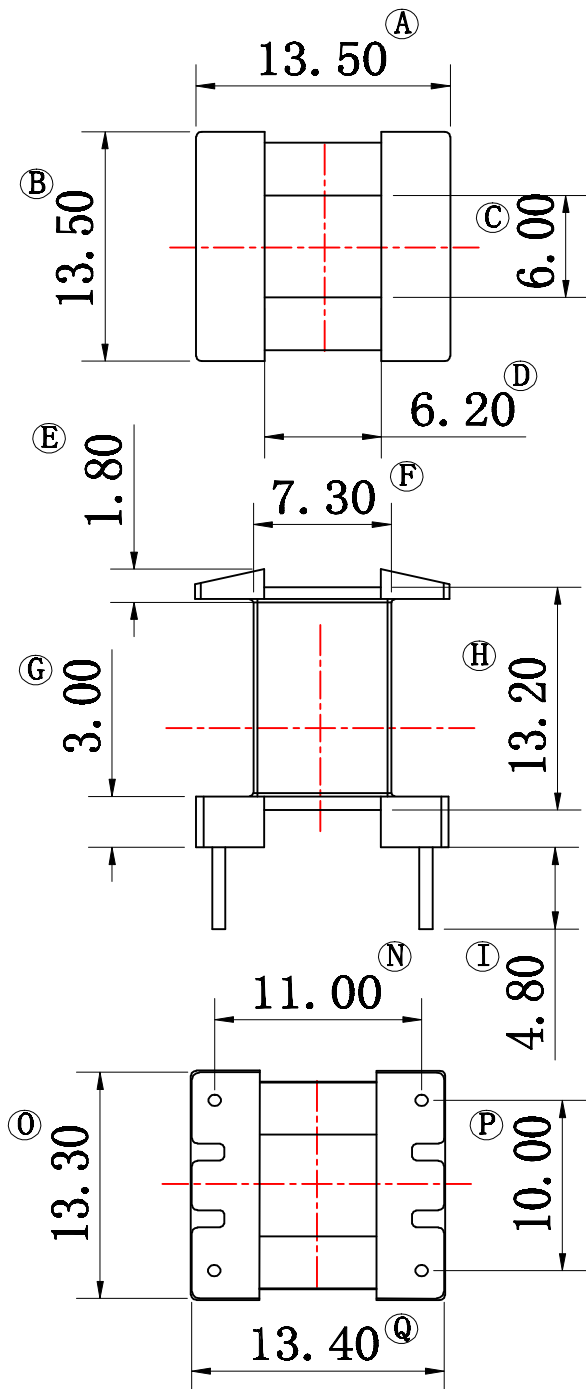

REV	REVISION RECORD	DATE	REV	REVISION RECORD	DATE
A			C		
B			D		
NAME	EE20 2+2P	MATERIAL	PHENOLIC	SCALE	ANGLE $\pm 1^\circ$
DRAWING NO.	FWB2073-J	PIN MATERIAL	CP WIRE	UNIT m/m	REV A
TOLERANCE OF PIN PITCH ± 0.20				HAINING FERRIWO ELECTRONICS CO.,LTD. TEL: +86-573-87088701 FAX: +86-573-87081130 Web: www.ferriwo.com Email: sales@ferriwo.com	
PIN TENSION LOAD kg MN		UL REC: 94V-0			
TOLERANCE: $0 < L \leq 4: \pm 0.2$ $4 < L \leq 16: \pm 0.3$ $16 < L \leq 63: \pm 0.4$					